

M30

- 2 membrane semidrauliche, collettori interni, parti a contatto coi liquidi ossidate anticorrosione, comando incorporato o a distanza.
- 2 diaphragms semi-hydraulic, internal manifolds, all parts in contact with liquids are anodized anti-corrosion, control assembly incorporated or remote.
- 2 membranas semihidráulicas, colectores internos, partes en contacto con líquidos anodizadas anticorrosión, mando incorporado o a distancia.
- 2 membranes semi-hydrauliques, clavatures dans le carter, parties en contact avec le liquide anodisées, groupe de commande incorporé ou à distance.
- Boxerpumpe mit 2 Kolben-Membranen halb-hydraulisch gestützt. Integrierte Saug-Druckkanäle, Kontrollventil angeflanscht oder Fernbedienung. Flüssigkeitsführende Teile rostbeständig anodisiert.

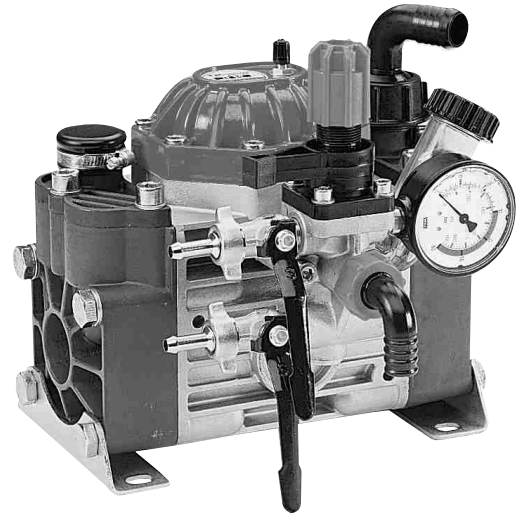

IMPIEGHI

Irrorazione, disinfestazione.

APPLICATIONS

Spraying, disinfecting.

APLICACIONES

Pulverización, desinfección.

EMPLOIS

Pulvérisation, désinfection.

VERWENDUNGEN

Spritzen, Entwesung.

COMPONENTI	MATERIALI	COMPONENTS	MATERIALS	COMPONENTES	MATERIALES	COMPOSANTS	MATERIAUX	TEILE	MATERIALEN
carter	alluminio	pump body	aluminium	cuerpo bomba	aluminio	carter	aluminium	Gehäuse	Aluminium
testata	^ alluminio anodizzato	pump head	^ anodized aluminium	culata	^ aluminio anodizado	culasse	^ aluminium anodisé	Zylinderkopf	^ anodiert Aluminium
collettori	alluminio	manifolds	aluminium	colectores	aluminio	clavatures	aluminium	Saug-Druckkanälen	Aluminium
valvola a.-m.	acciaio inox	check valve	stainless steel	válvula a.-m.	acero inox	clapet asp. ref.	acier inox	Ventil	rostfreier Stahl
cappellotto valvola	resina sintetica	valve cage	synthetic resin	cajera válvula	resina sintetica	cage du clapet	resine synthetique	Ventilkäfig	Kunstharz
membrana	* gomma nitrilica	pump diaphragm	* nitril rubber	membrana	* goma nitrilica	membrane	* caoutchouc nitrilique	Membrane	* Gummi
camera aria	gomma nitrilica	dumper diaphragm	nitril rubber	membrana calderin	goma nitrilica	chambre à air	caoutchouc nitrilique	Windkessel-membrane	Gummi
albero	acciaio cement. e temperato	pump shaft	casehardened steel	cigüeñal	acero cement. y templado	vilebrequin	acier cementé et trempé	Kurbelwelle	gehärteter Stahl

* OPTIONAL DESMOPAN

* OPTIONAL DESMOPAN

* OPTIONAL DESMOPAN

* OPTIONAL DESMOPAN

* OPTIONAL DESMOPAN

^ OPTIONAL CATAFORESI

^ OPTIONAL CATAPHORESIS

^ OPTIONAL CATAFORESI

^ OPTIONAL CATAPHORÈSE

^ OPTIONAL KATAPHORESE

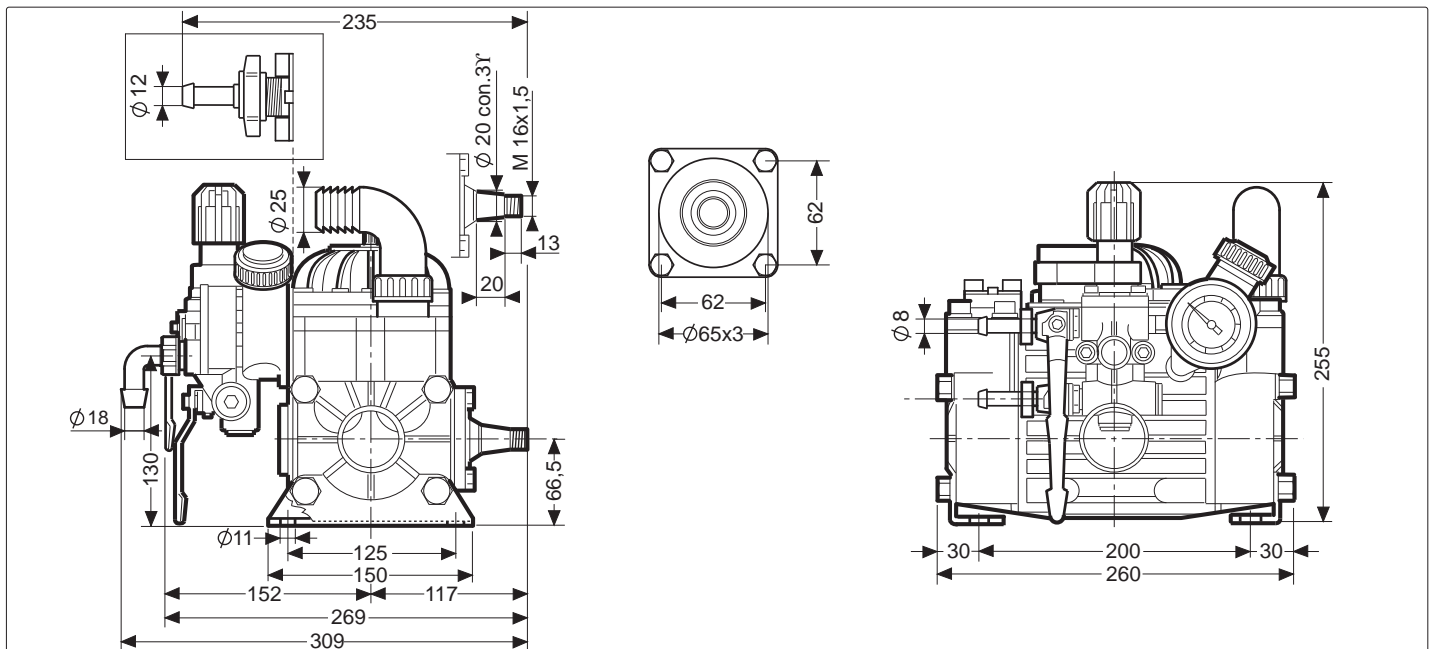

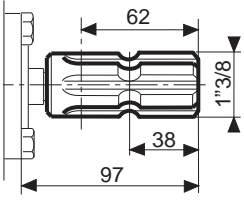

Cardano maschio 1"3/8
1"3/8 P.T.O. male
Cigüeñal estriado macho 1"3/8
Cardan male 1"3/8
Kardanzapfen 1"3/8 M.

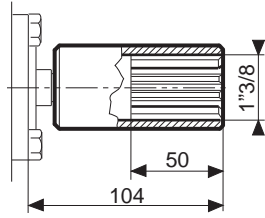

Cardano femmina 1"3/8
1"3/8 P.T.O. female
Cigüeñal estriado hembra 1"3/8
Cardan femelle 1"3/8
Kardan 1"3/8 F.

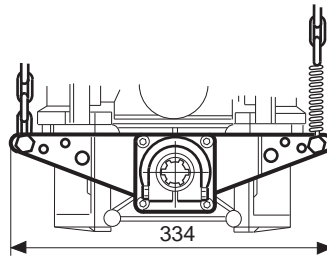

Attacco rapido 1"3/8 F.
Quick coupler 1"3/8 F.
Enganche 3 puntos toma de fuerza H. 1"3/8
Prise rapide 1"3/8 F.
3-Punkt Schnellschluß 1"3/8 mit Ketten

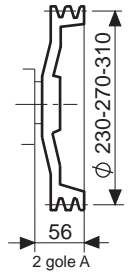
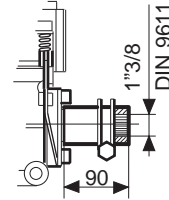

Puleggia
Pulley
Polea
Poulie
Keilriemenscheibe

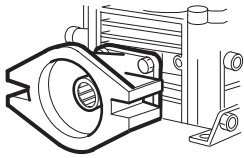

Flangiatura diretta
Direct flange
Brida directa
Bridage direct
Direkter Kupplungsflansch

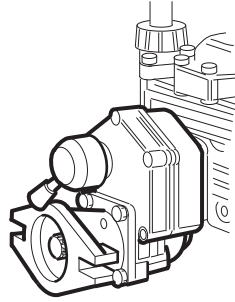

Flangiatura con riduttore e disinnesto
Flange with red. gear and disconnect
Brida con reductora y desembrague
Bride avec réducteur et débrayage
Flansch mit Untersetzungsgetriebe und Ausrückvorrichtung

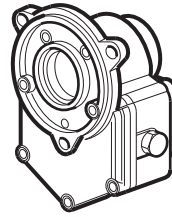

Riduttore per accoppiamento monoblocco
Gearbox for close coupling
Reductora directa
Réducteur monobloc
Untersetzungsgetriebe für Blockkupplung

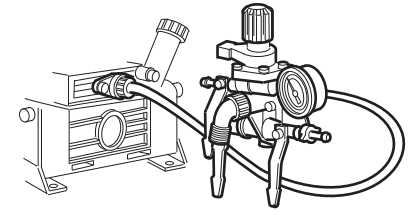

Comando a distanza
Remote control
Mando a distancia
Commande à distance
Fernbedienung

VERSIONI

Albero conico ø 20 mm, motopompe.

Giri/1': max 550
Pressione: max 30 BAR
Portata: max 32 lt/1'
Peso: kg 11,5
Max. disp. asp.: mt 3

Max RPM: 550
Pressure: max 30 BAR
Capacity: max 32 lt/1'
Weight: kg 11.5
Max suction lift: mt 3

RPM max: 550
Presión: max 30 BAR
Caudal: max 32 lt/1'
Peso: kg 11.5
Max disp. asp.: mt 3

Tours/1' max: 550
Pression: max 30 BAR
Débit: max 32 lt/1'
Poids: kg 11.5
Max haut. asp.: mt 3

Umdr. pro Minute: max 550
Druck: max 30 BAR
Förderstrom: max 32 lt/1'
Gewicht: kg 11.5
Max Ansaughöhe: mt 3

VERSIONS

Tapered shaft ø 20 mm, pump sets.

VERSIONES

Eje cónico ø 20 mm, motobombas.

VERSIONS

Arbre conique ø 20 mm, motopompes.

AUSFÜHRUNGEN

Konische Welle ø 20 mm, Motorpumpen.

USG LT/1'

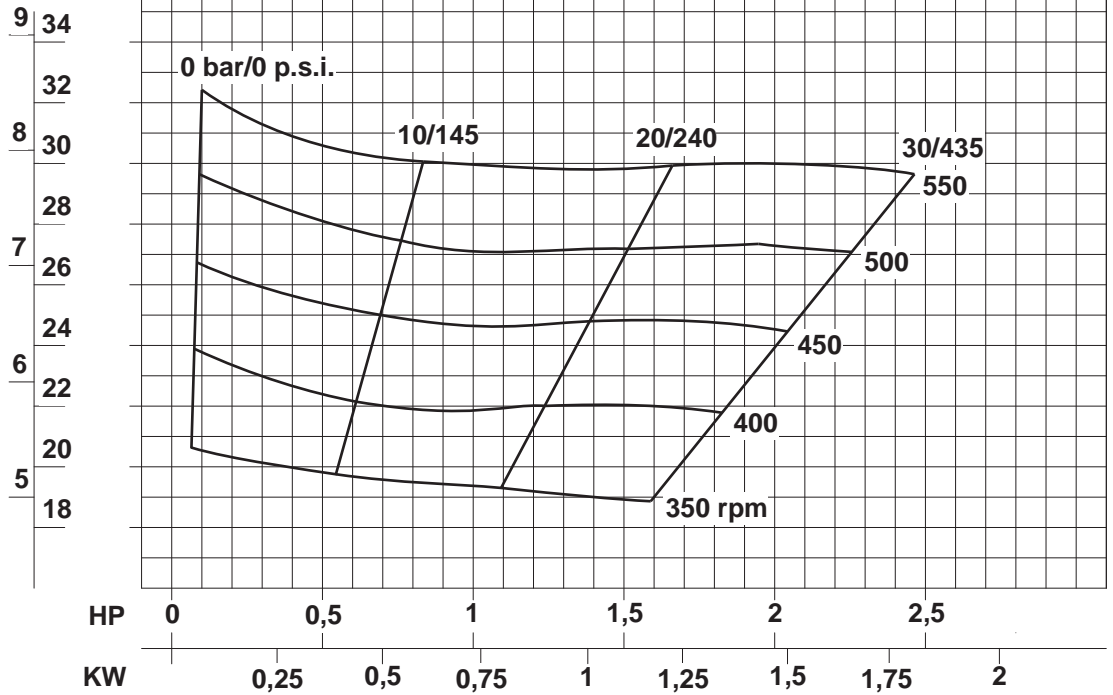

DATI INFORMATIVI

INDICATIVE DATA

DATOS INDICATIVOS

DONNÉES À TITRE D'INFORMATION

KENNDATEN UNVERBINDLICH



imovilli pompe S.r.l.

Via Masaccio, 1 Zona Industriale Mancasale - 42010 Reggio Emilia Italy Tel. +39 0522 516595 Fax +39 0522 514735

www.imovillipompe.it • e-mail: info@imovillipompe.it